

# e-ASK

electronic **A**ccess **S**ecurity **K**eyless-entry

## **Multiplex System** **Installation & Instructions** (UM15 ~ 22272-03)



500 Bailey Avenue  
P.O. Box 350  
New Hampton, Iowa 50659 U.S.A.  
Tel: 641-394-3188  
Fax: 641-394-2392  
[www.trimarkcorp.com](http://www.trimarkcorp.com)

# Table of Contents

- Introduction** ..... 1
- Standard e-FOB Operation and Features** ..... 2
- Cargo e-FOB Operation and Features** ..... 2
- Non-doorbell e-PAD Operation and Features** ..... 3
- Doorbell e-PAD Operation and Features** ..... 3
  - Lock Doors With Keypad ..... 4
  - Secure Operations ..... 4
  - Doorbell ..... 4
  - e-ASK Configuration — Non-doorbell** ..... 5
    - Configuration A [SW 1 off / SW 2 off] ..... 5
    - Configuration B [SW 1 off / SW 2 on] ..... 5
    - Configuration C [SW 1 on / SW 2 off] ..... 5
    - Configuration D [SW 1 on / SW 2 on] ..... 5
  - e-ASK Configuration — Doorbell** ..... 6
    - Configuration A [SW 1 off / SW 2 off] ..... 6
    - Configuration B [SW 1 off / SW 2 on] ..... 6
    - Configuration C [SW 1 on / SW 2 off] ..... 6
    - Configuration D [SW 1 on / SW 2 on] ..... 6
- Additional Features** ..... 7
  - Dome/Porch Light Activation ..... 7
  - e-PAD Protective Deactivating Security Feature** ..... 7
  - e-GRAB Handle Lighting** ..... 7
  - DIP Switch Settings for Keypad Configurations ..... 7
    - Configuration A [SW 1 off / SW 2 off] ..... 7
    - Configuration B [SW 1 off / SW 2 on] ..... 7
    - Configuration C [SW 1 on / SW 2 off] ..... 8
    - Configuration D [SW 1 on / SW 2 on] ..... 8
  - Trim Pot Variable Resistors ..... 8
  - S2 DIP Switches ..... 9
    - Switches 1 and 2 ..... 9
    - Switch 3 ..... 9
    - Switch 4 ..... 9

Learn Switch Connector .....	10
Status LED .....	10
Miscellaneous I/O Module Features.....	10
Door Locking and Unlocking .....	10
Lock and Unlock Confirmation.....	10
Deactivate Lock Confirmation.....	10
Door Ajar Warning .....	11
Unidirectional Actuation Pulse .....	11
Alarm.....	11
Timed Dome/Porch Light Activation .....	12
Compartment Light Activation.....	12
Automatic Locking and Unlocking .....	12
Auxiliary 1 Output Activation.....	12
<b>Teaching Additional Transmitter FOBs.....</b>	<b>13</b>
<b>Teaching Keypad New Authority / Access Codes.....</b>	<b>14</b>
Assign New Access Codes .....	15
<b>Troubleshooting .....</b>	<b>16</b>
<b>Appendix A: Mounting e-ASK Components .....</b>	<b>I</b>
<b>Appendix B: Wiring Color Code Tables and Diagrams .....</b>	<b>II</b>
Table 1: RF Receiver Assignments.....	II
Table 2: Ignition Connections.....	II
Table 3: Relay Output Connections .....	III
Table 4: Other Vehicle Connections.....	IV
Diagram 1: Actuator Wiring .....	V
Diagram 2: Auxiliary Outputs Wiring .....	VI
Diagram 3: Switch Input Wiring .....	VI

## Introduction

This manual provides the necessary information for the proper installation and use of TriMark's **e-ASK** System. The **e-ASK** system comes with the following components:

- **e-FOB** (keyless entry radio frequency [RF] FOB transmitter and receiver)
- **e-PAD** keypad user interface or **e-GRAB** keypad integrated grab handle. **Clean acrylic rod with mild soap and water only.**
- **e-ASK** I/O module

Use the pictures below to properly identify the contents of this system.

**I/O module with RF receiver**



**e-GRAB Handle**



**Keypad** — available vertical or horizontal



## Standard e-FOB Operation and Features

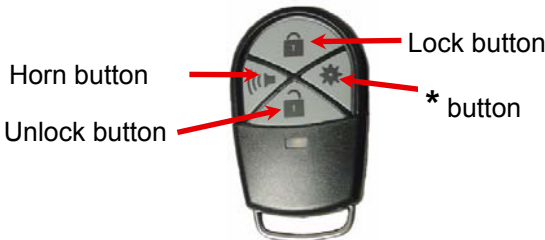

Button	Function
<b>Lock</b>	Locks doors and arms security system.
<b>Unlock</b>	Unlocks doors and disarms security system. Also activates the porch light.
<b>Horn</b>	Activates panic mode when pressed and held for 2 seconds.
<b>* button</b>	Auxiliary output. Possible assignment include: interior/ exterior lighting, awning extension/retraction, gas cap, hood, etc.

## Cargo e-FOB Operation and Features

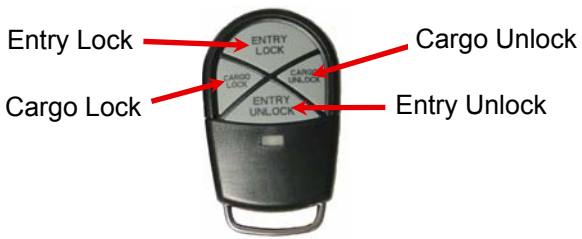

Button	Function
<b>Entry Lock</b>	Locks entry door and arms security system.
<b>Entry Unlock</b>	Unlocks entry door and disarms security system. Also activates the porch light.
<b>Cargo Lock</b>	Locks cargo doors and arms security system.
<b>Cargo Unlock</b>	Unlocks cargo doors and disarms security system. Also activates compartment lights.

**Notes:**

- The FOB transmitters and receiver are shipped programmed. After making all necessary wiring connections (see Appendix B, page II for wiring information), the **e-FOB** system will function as shown.
- Only the unlocking function of the **e-FOB** remains while the engine is running—other functions are deactivated.

## **Non-doorbell e-PAD Operation and Features**

The **e-PAD** is shipped with default authority and access codes. Unless the OEM or dealer has changed default codes, the authority and access codes are as follows:

Access code:

Digit 1	Digit 2	Digit 3	Digit 4	Digit 5
1 / 2	3 / 4	5 / 6	7 / 8	9 / 0

Authority code:

Digit 1	Digit 2	Digit 3	Digit 4	Digit 5
7 / 8	7 / 8	7 / 8	7 / 8	7 / 8

## **Doorbell e-PAD Operation and Features**

Access code:

Digit 1	Digit 2	Digit 3	Digit 4	Digit 5
1	2	3	4	4

Authority code:

Digit 1	Digit 2	Digit 3	Digit 4	Digit 5
4	4	4	4	4

## Lock Doors With Keypad

Press and hold down the (1 / 2) or (1) button for 1-2 seconds. An access code is not needed to lock the doors.

## Secure Operations

Entering a valid 5-digit access code enables secure operations. After entering an access code, the keypad is enabled for 5 seconds and a 6th button press initiates a secure operation, such as unlocking the doors.

### Notes:

- The authority code does not allow for secure operations. It is only used to assign access codes (see page 15 for information on setting access codes).
- If an unassigned button or no button is pressed while the system is enabled, the keypad reverts back to disabled state.
- The secure keypad operations are set depending on the system configuration.

## Doorbell

Press and release the doorbell button on a doorbell keypad. The doorbell does not require an access code. When the I/O module sees a doorbell command from the keypad, an output pulse is provided from zone 6.

## **e-ASK Configuration — Non-doorbell**

The following operations are dependent on system configuration. Entering a 5-digit access code enables the keypad. After entering the access code, one must press a 6th digit to unlock specific doors or perform an operation according to the following listing.

### **Configuration A [SW 1 off / SW 2 off]:**

- Button (1 / 2): Unassigned
- Button (3 / 4): Unlocks all entry and compartment doors
- Button (5 / 6): Unassigned
- Button (7 / 8): Toggles Aux 1 output
- Button (9 / 0): Activates zone 6 unidirectional actuation

### **Configuration B [SW 1 off / SW 2 on]:**

- Button (1 / 2): Unlocks all entry door(s)
- Button (3 / 4): Unlocks all entry and compartment doors
- Button (5 / 6): Unassigned
- Button (7 / 8): Toggles Aux 1 output
- Button (9 / 0): Activates zone 6 unidirectional actuation

### **Configuration C [SW 1 on / SW 2 off]:**

- Button (1 / 2): Unlocks all entry doors
- Button (3 / 4): Unlocks all doors assigned to relay bank A
- Button (5 / 6): Unlocks all doors assigned to relay bank B
- Button (7 / 8): Unlocks all doors assigned to relay bank C
- Button (9 / 0): Unlocks all doors assigned to relay bank D

### **Configuration D [SW 1 on / SW 2 on]:**

- Button (1 / 2): Unlocks all entry doors
- Button (3 / 4): Unlocks all entry and compartment doors
- Button (5 / 6): Unlocks all curb side compartment doors (relay banks C-D)
- Button (7 / 8): Unlocks all driver side compartment doors (relay banks A-B)
- Button (9 / 0): Toggles Aux 1 output

#### **Note:**

- See the table on page 9 for S2 DIP switch assignments.
- Configuration D is the default.



## **e-ASK Configuration — Doorbell**

The following operations are dependent on system configuration. Entering a 5-digit access code enables the keypad. After entering the access code, one must press a 6th digit to unlock specific doors or perform an operation according to the following listing.

### **Configuration A [SW 1 off / SW 2 off]:**

- Button (1): Unassigned
- Button (2): Unlocks all entry and compartment doors
- Button (3): Unassigned
- Button (4): Toggles Aux 1 output
- Button doorbell : Activates zone 6 unidirectional actuation

### **Configuration B [SW 1 off / SW 2 on]:**

- Button (1): Unlocks all entry door(s)
- Button (2): Unlocks all entry and compartment doors
- Button (3): Unassigned
- Button (4): Toggles Aux 1 output
- Button (doorbell): Activates zone 6 unidirectional actuation

### **Configuration C [SW 1 on / SW 2 off]:**

- Button (1): Unlocks all entry doors
- Button (2): Unlocks all doors assigned to relay bank A
- Button (3): Unlocks all doors assigned to relay bank B
- Button (4): Unlocks all doors assigned to relay bank C
- Button (doorbell): Activates zone 6 unidirectional actuation

### **Configuration D [SW 1 on / SW 2 on]:**

Configuration D is standard for doorbell.

- Button (1): Unlocks all entry doors
- Button (2): Unlocks all entry and compartment doors
- Button (3): Unlocks all compartment doors (banks C-D)
- Button (4): Unlocks all compartment doors (banks A-B)
- Button (doorbell): Activates zone 6 unidirectional actuation

### **Note:**

- See the table on page 9 for S2 DIP switch assignments.
- Configuration D is the default.

# **Additional Features**

## **Dome/Porch Light Activation**

The dome/porch light is activated for a timed duration (5-60 seconds) whenever a keypad button is pressed or when system is unlocked from FOB transmitter or vehicle switch. The time duration is dependent on the trim pot A setting (see page 8). The dome/porch light is deactivated with starting the engine and locking the entry doors.

## **e-PAD Protective Deactivating Security Feature**

After repeated entry of incorrect codes (20 button presses without enabling), the keypad enters an inactive mode that disables button recognition for 1 minute. This helps prevent undesired access by entering random codes. No beep will sound with button press while the system is disabled.

## **e-GRAB Handle Lighting**

The grab handle is lit continuously. The **e-PAD** is lit with a button press and while training new access and authority codes.

## **DIP Switch Settings for Keypad Configurations**

The following vehicle switch assignments of connector J2 (see Appendix B, page IV), pins 1 thru 6 define outputs due to an interior switch. These are the I/O module inputs that correspond to the 6th button press operations. When a pin is grounded, its corresponding function is specified.

### **Configuration A [SW 1 off / SW 2 off]**

- Pin 1: Locks all doors
- Pin 2: Unlocks all doors
- Pin 3: Unassigned
- Pin 4: Unassigned
- Pin 5: Unassigned
- Pin 6: Unassigned

### **Configuration B [SW 1 off / SW 2 on]**

- Pin 1: Locks all doors
- Pin 2: Unlocks all doors
- Pin 3: Locks all compartment doors (banks A-D, not entry door relays)
- Pin 4: Unlocks all compartment doors (banks A-D, not entry door relays)
- Pin 5: Locks entry door(s)
- Pin 6: Unlocks entry door(s)

### **Configuration C [SW 1 on / SW 2 off]**

- Pin 1: Locks all doors
- Pin 2: Unlocks entry door(s)
- Pin 3: Unlocks bank A compartment(s)
- Pin 4: Unlocks bank B compartment(s)
- Pin 5: Unlocks bank C compartment(s)
- Pin 6: Unlocks bank D compartment(s)

### **Configuration D [SW 1 on / SW 2 on]**

- Pin 1: Locks all doors
- Pin 2: Unlocks all doors
- Pin 3: Unlocks curb-side compartment doors (banks C-D)
- Pin 4: Unlocks driver-side compartment doors (banks A-B)
- Pin 5: Locks entry door(s)
- Pin 6: Unlocks entry door(s)

## **Trim Pot Variable Resistors**

These trim pots provide adjustable settings for timed outputs. Clock-wise rotation increases activation time (see Appendix B, page IV).

- Trim pot A (R31) is assigned to dome/porch light activation (5-60 second range).
- Trim pot B (R32) is assigned to Auxiliary 1 output (0.5-5.0 minute range).
- Trim pot C (R33) is assigned to Auxiliary 2 compartment lighting output (0.5-5.0 minute range).

### **Notes:**

- Trim pot settings are updated every 30 seconds.
- Trim pot adjustments may not be observed immediately.

## S2 DIP Switches

The S2 DIP switch is located under the I/O module cover. Functional assignments are described below.

### Switches 1 and 2

Provide functional assignment of how relay banks A-D are grouped. The following table shows the configuration type (A-D), DIP switch assignment, and subsequent relay assignment. Configuration D is standard.

Configuration	Switch 1	Switch 2	Relay bank grouping
A	Off	Off	1 group exists. All banks are grouped with entry door.
B	Off	On	2 groups exist. #1 entry group. #2 group to banks A, B, C, and D.
C	On	Off	5 groups exist. # 1 entry. #2 to bank A, #3 to bank B, #4 to bank C, and #5 to Bank D.
D	On	On	3 groups exist. #1 entry group. #2 group to banks A and B. #3 group to banks C and D.

### Switch 3

Controls auto locking and unlocking via engine input.

- Switch 3 ON: auto locking and unlocking activated.
- Switch 3 OFF: auto locking and unlocking deactivated.

### Switch 4

Defines standard mode or cargo mode for the FOB transmitter.

- Switch 4 ON: cargo mode. The top and bottom center buttons lock and unlock entry doors. The left and right middle buttons lock and unlock compartment doors.
- Switch 4 OFF: standard mode. The top and bottom center buttons lock and unlock all doors. The left and right middle buttons control the panic and auxiliary 1 functions.

## Learn Switch Connector

The learn switch connector is used to reset the keypad to assign a new authority code. See page 14 for further information on teaching keypad a new authority code.

## Status LED

LED flashes at power-up and provides short periodic pulses if voltage supply is low.

## Miscellaneous I/O Module Features

### Door Locking and Unlocking

A short single pulse output provides locking and unlocking operation to the entry doors (zone 1). The compartment doors (banks A-D) are locked and unlocked with a single pulse. The locking and unlocking pulses have opposite polarities. Locking and unlocking operations are activated via vehicle switch inputs or according to **e-PAD** and **e-FOB** instructions.

### Lock and Unlock Confirmation

- Standard mode: The headlights flash once and the horn honks once with a lock command. On unlock, the headlights flash twice and the horn honks twice.
- Cargo mode: There is no unlock confirmation. The headlights flash once and the horn honks once when either the entry or compartment doors are locked. When both entry and compartments doors are locked within 10 seconds, headlights flash twice and the horn honks twice.
- Keypad: The headlights flash once and the horn honks once with a lock command. On unlock, the headlights flash twice and the horn honks twice.
- Locking and unlocking confirmation is deactivated while engine is running.

### Deactivate Lock Confirmation

The system defaults to confirmation ON with power-up. Horn and headlight confirmation can be toggled off and on from the keypad.

1. Enter valid access code.
2. Hold down (9 / 0) or (4) button until double beep sounds. Release.
3. Press (1 / 2) or (1) button.

**Note:** Lights flash and horn honks to indicate that you are setting horn and headlight confirmation to ON.

### **Door Ajar Warning**

A triple siren chirp sounds if any compartment or entry door is open when the entry and compartment doors are locked. If a door is open, the alarm is not armed.

### **Unidirectional Actuation Pulse**

The J9 connector (Zone 6) actuation output provides a short pulse when it is activated via a vehicle switch, keypad (depends on system configuration), or FOB transmitter (depends on I/O module DIP switch #4 setting). This can be used for a door opening, doorbell, battery disconnect, etc. This short pulse output is prohibited while the engine is running.

### **Alarm**

After locking all doors, the system is armed. In cargo mode, both the entry door and compartment doors must be locked within 10 seconds to set the alarm. The alarm is activated when any entry door or compartment door is opened, or by grounding the extra security input.

The extra security input could be connected to a shock sensing, motion detection or other sensing device. When alarm is triggered, the siren is continuously activated and headlights flash for 1 minute.

To deactivate alarm mode:

- Unlock all doors via FOB transmitter.
- Unlock system via keypad or vehicle switch.
- Start the engine.

The following table describes audio/visual activations at various conditions.

<b>Outputs</b>	<b>Single Lock Confirmation</b>	<b>All Lock Confirmation</b>	<b>Alarm</b>
<b>Siren</b>	Not used	Not used	1 minute or when shut off
<b>Horn</b>	1 chirp	2 chirps	Not used
<b>Headlights</b>	1 flash	2 flashes	1 minute or when shut off

### **Timed Dome/Porch Light Activation**

The dome/porch light is activated upon pressing any keypad button or by unlocking entry door via FOB transmitter. The activation duration is controlled via trim pot A (see page 8). Starting the engine or locking the doors deactivates the light.

### **Compartment Light Activation**

Compartment lights are activated upon unlocking compartment doors (bank A-D) or toggling vehicle switch. The activation duration is controlled via trim pot C (see page 8). Starting the engine deactivates the light.

### **Automatic Locking and Unlocking**

When S2 DIP switch # 3 is ON the auto-locking feature is activated. All doors are locked after the engine has been running for 5 seconds. Doors unlock when the engine is turned off. To deactivate this feature, move DIP switch #3 to OFF. The alarm is not enabled/disabled by automatic locking/unlocking.

### **Auxiliary 1 Output Activation**

Standard Mode: With proper wiring and system configuration, Aux 1 output can be activated with \* button on FOB transmitter, via keypad, or toggled with vehicle switch. The activation duration is controlled via trim pot B. Starting the engine deactivates the output.

# Teaching Additional Transmitter FOBs

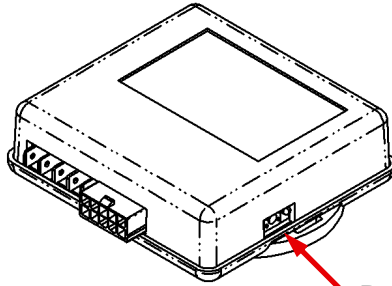
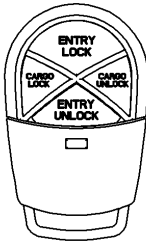

**Programming  
button/LED**

1. Turn ignition off and disarm alarm.
2. Press and release the programming button 3 times. The LED will turn on after 3 seconds.
3. Press and release the lock button of each new FOB transmitter once. The LED will flash. Up to 4 transmitters may be programmed at one time.
4. Confirm that FOB transmitters lock/unlock system.

## **Notes:**

- If you place the system in learn mode and teach nothing, the system will exit in 10 seconds.
- When new transmitters are taught, all old transmitters are erased.
- The memory for codes is NON-VOLATILE and will not be erased if power is removed.
- As soon as the LED turns off, the system is fully functional.



## Teaching Keypad New Authority / Access Codes

When you assign a new authority code, you delete the existing authority code and all access codes.

**Note:** The authority code you assign following these instructions also becomes an access code saved to the (1 / 2) or (1) button.

1. Cycle (short then open) the S1 pins of the I/O module learn connector (Appendix B, page IV). There will be three-second beep.
2. Enter a new five-digit code—this will be your access and authority code.
3. Enter the new code again.
4. The existing code will only be erased if a new code is assigned.
5. The code is stored in position one.

**Important:** Authority and access codes should not be the same. If someone figures out an access code and discovers it to be an authority code as well, they can then create their own access code and gain entrance to your vehicle.

Once resetting the keypad, your next step should be to create a new access code and store it in position one so as to ensure the access code is no longer the same as the authority code.

### Notes:

- The authority code is to be controlled by individuals (owners of vehicle, fleet manager, etc.) who manage the distribution of access codes to vehicle users.
- The authority code should be changed when the vehicle is sold.
- The authority code does not enable secure functions (lock/unlock doors, etc.)—it is only used to assign access codes.

The following area can be used to document the authority code:

Authority Code				
Digit 1	Digit 2	Digit 3	Digit 4	Digit 5

## Assign New Access Codes

With a valid authority code (see page 3 or 14), an access code can be programmed with the following instructions.

1. Press the (5 / 6) or (3) button for 5 seconds, the keypad will beep. The backlighting LED of the keypad will flash indicating the learn mode.
2. Enter in the 5-digit authority code (see page 3 or 14). Keypad will provide a long beep that will stop after you have defined an access number.
3. Press and release the button that corresponds to the access number. For example, press (1 / 2) or (1) button for access #1 and press (3 / 4) or (2) button for access #2. During this activity you are defining 1 of 5 (4) access numbers. A subsequent code will be assigned to this access #. The keypad will provide a confirmation beep after this single button press.
4. Enter in your new 5-digit access code. The keypad will provide confirmation beeps.
5. Re-enter new access code. The keypad will provide confirmation beeps.

Repeat process to assign additional access codes.

Up to 5 (4 for doorbell keypad) different access codes can be assigned at one time. As additional access codes are defined, pre-existing access codes are overwritten. For example, if a new access code is assigned for access #3, the previous access #3 code is no longer valid.

The following area can be used to document the access code assignments.

Access #	User Name	Digit 1	Digit 2	Digit 3	Digit 4	Digit 5
1						
2						
3						
4						
5						

# Troubleshooting

Problem Description	Possible Solution
<b>e-FOB Hints</b>	
Button press does not provide correct operation	Verify power to the I/O module and RF receiver.
	Re-teach the FOB transmitter to the receiver. Ensure that only Lock button is pressed while in learn mode.
No operation or intermittent operation	Mount RF receiver away from enclosed metal areas and fully extend antenna.
	Check FOB transmitter battery voltage. Batteries need to be changed every 1-2 years depending on usage.
Alarm mode starts when powered up	Press Unlock button of FOB transmitter.
One particular <b>e-FOB</b> function does not work	Check wire connection of affected function at RF module, wiring harness, and I/O module.
Zone 6 activated inadvertently	Verify that Zone 6 is not connected to the cargo button on the FOB transmitter. The cargo button can activate both outputs.
<b>e-PAD Hints</b>	
No response with button press	Verify power to the I/O module.
	Verify that keypad cable is connected. (rest of system will function)
Access code is not recognized	Verify that code has not been changed. Reassign keypad with instructions on starting on page 14.
	Confirm use of an access code, not the authority code.
Key FOB works correctly, keypad beeps, but no output	Cycle power to I/O module.
Unexpected, secure operation occurs	Verify DIP switches are set to correct configuration setting.

## e-ASK I/O Hints

No response in any system element	Verify power to the I/O module.
Lights and panic mode do not turn off with ignition start	Verify that connector J11, pins 7, 8 and 9 are wired properly.
Output relay latches on or off	Verify that power to relay comes from connector J12, pin 1.
	Cycle power to system. If condition continues, replace relay.

# Appendix A: Mounting e-ASK Components

Contact TriMark for specific mounting details, such as drawings, placement suggestions, mounting hardware, etc.

## General Mounting Guidelines:

- The RF receiver should be placed in an interior location that does not shield RF signals. You may need to try multiple locations to optimize reception. The antennae must be left fully extended and exposed. Minimize shielding from metal enclosures.
- Top surface of the I/O module has features that can be self-tapped with a #8-32 fastener. Fasteners should not be longer than 0.5 inches in thread length. Also other components, wiring holders, etc. can be mounted with these features.
- Mount **e-PAD** to vehicle. Plug the 4-pin connector into the J3 or J4 connector on the I/O module.

**RF Receiver Module**

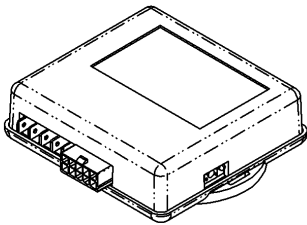

**I/O Module**

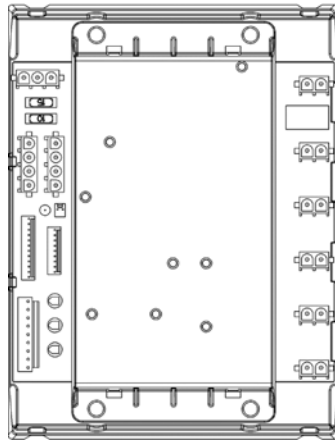

## Appendix B: Wiring Color Code Tables and Diagrams

The following tables and diagrams are provided to show color-coded wire and pin assignments for the e-ASK system.

**Table 1: RF Receiver Assignments**

Wire Colors	10-Pin Harness	
BLACK	SYSTEM GROUND	1
--	--	2
--	--	3
BLUE	CARGO LOCK OUTPUT	4
ORANGE	ENTRY LOCK OUTPUT	5
RED	+12V POWER	6
--	--	7
--	--	8
PURPLE	CARGO UNLOCK OUTPUT	9
BROWN	ENTRY LOCK OUTPUT	10

**Table 2: Ignition Connections**

Wire Colors	6-Pin Harness	
--	--	1
--	--	2
WHITE/BLACK	STATUS COMMON	3
GREEN/WHITE	ENGINE RUNNING	4
WHITE/BROWN	KEY INSERTED	5
--	--	6



### Table 3: Relay Output Connections

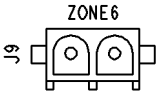

J9 CONNECTOR: Unidirectional Actuation Output (E.G. Door Opening , Battery Disconnect, Doorbell)

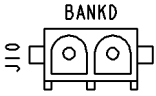

J10 CONNECTOR: Lock/Unlock Bank D

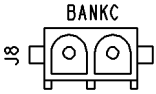

J8 CONNECTOR: Lock/Unlock Bank C

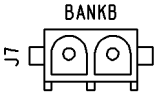

J7 CONNECTOR: Lock/Unlock Bank B

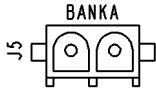

J5 CONNECTOR: Lock/Unlock Bank A

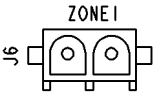

J6 CONNECTOR: Lock/Unlock Zone 1 (Entry)



# Table 4: Other Vehicle Connections

### Trimpot A

Sets Timed Dome/  
Porch Light Output  
(CW Increases  
Duration)

### Trimpot B

Sets Timed Aux 1  
output (CW Increases  
Duration)

### Trimpot C

Sets Timed Aux 2  
Compartment Light  
Output (CW Increases  
Duration)

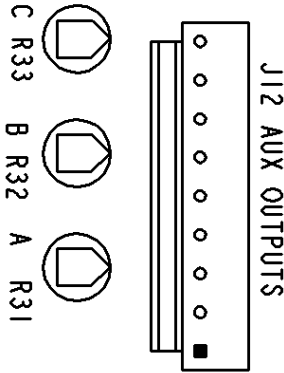

### J12 AUX OUTPUT

Relay Driver Outputs - Pin  
Assignments

- PIN 1: +12 v
- PIN 2: Horn
- PIN 3: Headlight Or Marker  
Lights
- PIN 4: Interior Light / Porch  
light
- PIN 5: Auxiliary 1
- PIN 6: Auxiliary 2-  
Compartment Lights
- PIN 7: Entry Door Ajar
- PIN 8: Compartment Door  
Ajar
- PIN 9: Siren

**NOTE: Pins 2-9 Sink To  
Ground Upon Activation.  
Pin 1 To Be Used As (+12  
V) Opposite Side Of Relay  
Coil.**

### J11 INPUTS

Inputs For RF Receiver  
And Vehicle Status— Pin  
Assignments:

- PIN 9: Power/  
Ground (connect to  
+12 or ground,  
depends if pins 7  
and 8 are sinks or  
sources)
- PIN 8: Engine  
Running
- PIN 7: Key Inserted
- PIN 6: Cargo Lock  
From RF Receiver
- PIN 5: Cargo  
Unlock from RF  
Receiver
- PIN 4: Unlock from  
RF Receiver
- PIN 3: Lock from RF  
Receiver
- PIN 2: +12 VDC to  
RF Receiver
- PIN 1: Ground to  
RF Receiver

### S1 LEARN INPUT

Input To Reset Keypad  
Codes

### D19 STATUS LED

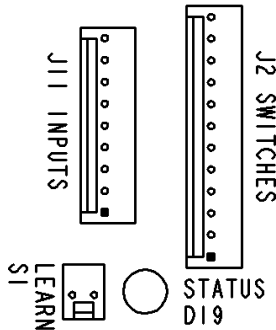

### J2 SWITCH

(Connect to ground to activate)  
Pin Assignments:

- PIN 12: Security System
- PIN 11: Compartment Door  
Ajar
- PIN 10: Entry Door Ajar
- PIN 9: Auxiliary 2 Toggle
- PIN 8: Auxiliary 1 Toggle
- PIN 7: Actuate Zone 6
- PIN 6: Depends On Dip  
Switch Config.
- PIN 5: Depends On Dip  
Switch Config.
- PIN 4: Depends On Dip  
Switch Config.
- PIN 3: Depends On Dip  
Switch Config.
- PIN 2: Depends On Dip  
Switch Config.
- PIN 1: Depends On Dip  
Switch Config.

**NOTE: PINS 1-6 Provide Different  
Locking And Unlocking Functions.  
Their Relay Bank Assignment  
Depends On S2 DIP Switch  
Setting. The Connection Of Both  
Pin 8 (Aux 1 Toggle) And Pin 7  
(Actuate Zone 6) Is Not  
Recommended.**



**J3 AND J4 TriNet Keypad Connectors**

- PIN 4: TriNet B
- PIN 3: TriNet A
- PIN 2: Ground
- PIN 1: +12 Volts

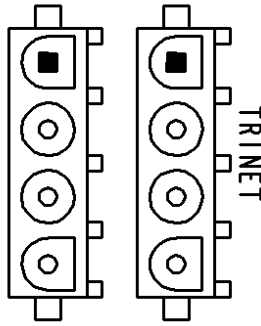

**J1 CONNECTOR**

Connect to a Reliable Power Source.

- PIN 3: GND
- PIN 2: GND
- PIN 1: +12 V

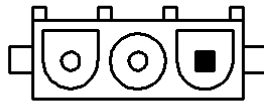

POWER

**F2: RED**

10-amp fuse protects TriNet Communications (Power And Communication) to the keypad.

**F3: BLUE**

15-amp fuse protects the power actuator outputs of the I/O module.

**Diagram 1: Actuator Wiring**

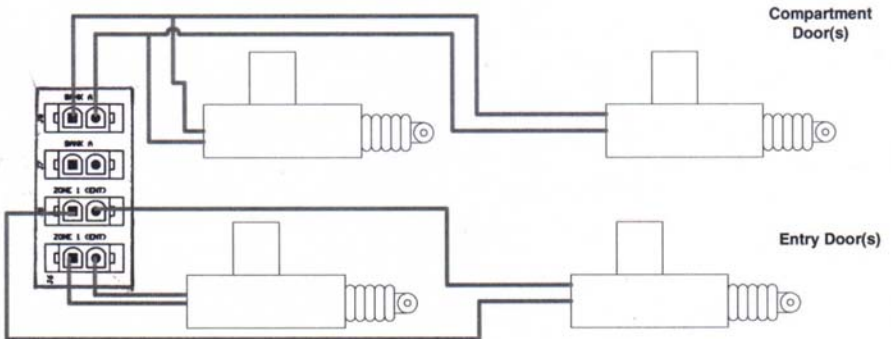

The cumulative current draw of actuators at each relay bank should not exceed 25-amp rating.

## Diagram 2: Auxiliary Outputs Wiring

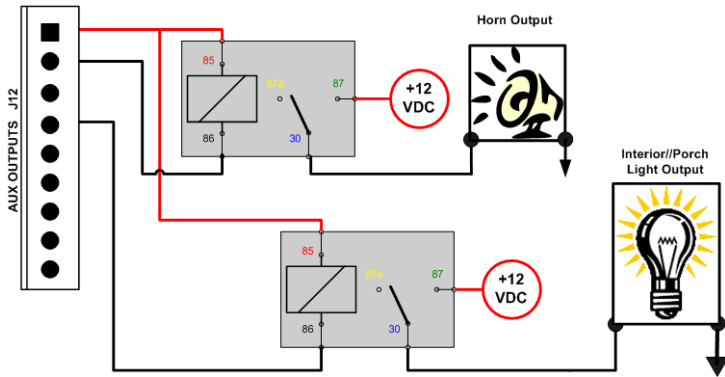

Auxiliary outputs provide relay driver ground signal.

Diagram illustrates typical relay connectivity. As shown, +12 V pin should be used to power coil of relays.

## Diagram 3: Switch Input Wiring

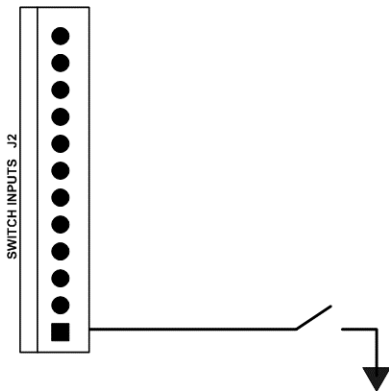

Switch inputs are activated when sunk to ground.

Diagram illustrates typical switch connectivity.

This product has been manufactured with methods to ensure high quality and to meet the high expectations of our customers. *TriMark* warrants this product to be free from workmanship defects and will remedy issues per *TriMark's* warranty policy.

Remote transmitter FOBs, batteries, and other equipment subject to normal wear and deterioration may need to be replaced periodically by dealer and/or end user and are not covered by this warranty. *TriMark* will not be liable for indirect, special, incidental or consequential damages.



500 Bailey Avenue  
P.O. Box 350  
New Hampton, Iowa 50659 U.S.A.  
Tel: 641-394-3188  
Fax: 641-394-2392  
[www.trimarkcorp.com](http://www.trimarkcorp.com)

UM15  
22272-03  
11/06-1