

TriMark has the experience....

MRAP **MRAP Light (M-ATV)**
MRAP+ **Pinzgauer**
MTVR **TAPV** **LVSR**
Up-Armoring
FMTV **JLTV**

 **TriMark**
DOOR SYSTEMS
Access to Excellence

TriMark Europe
Cedar Court
Walker Road
Bardon Hill, Coalville LE67 1TU
United Kingdom
Tel: +44 (0) 1530 512460
Fax: +44 (0) 1530 512461
E-mail: sales@trimarkeu.com
www.trimarkeu.com

TriMark Corporation
500 Bailey Avenue
P.O. Box 350
New Hampton, Iowa 50659
United States
Tel: +1 641-394-3188
Fax: +1 641-394-2392
E-Mail: tips@trimarkcorp.com
www.trimarkcorp.com

TMEU
05/12-1



**COMPLETE
DOOR
SYSTEMS**

ONE PIECE

ONE SUPPLIER

INFINITE SOLUTIONS

- Power Actuation
- Weight Saving Solutions
- Access Hardware

www.trimarkcorp.com

 **TriMark**[®]

Success Follows Experience

TriMark has been designing and manufacturing heavy duty hardware for over 35 years and has demonstrated the capability of the TriGuard products in the following areas; door modules and up-armor door kitting for MRAP and MTVR vehicles and is actively working on projects for the JLTV vehicle concepts and mock-ups. Already proven in several blast tests, the 050-0850 Heavy Duty Latch/Striker survives in punishing environments and provides rotor/cam assist to heavy doors/armor and hinges helping to compensate for door sag.

A High Quality System Uses the Best Components

TriMark's TriGuard line of heavy duty latches, linkages, handles, covers and complete door modules have been specifically developed for heavy duty and armored vehicle applications.

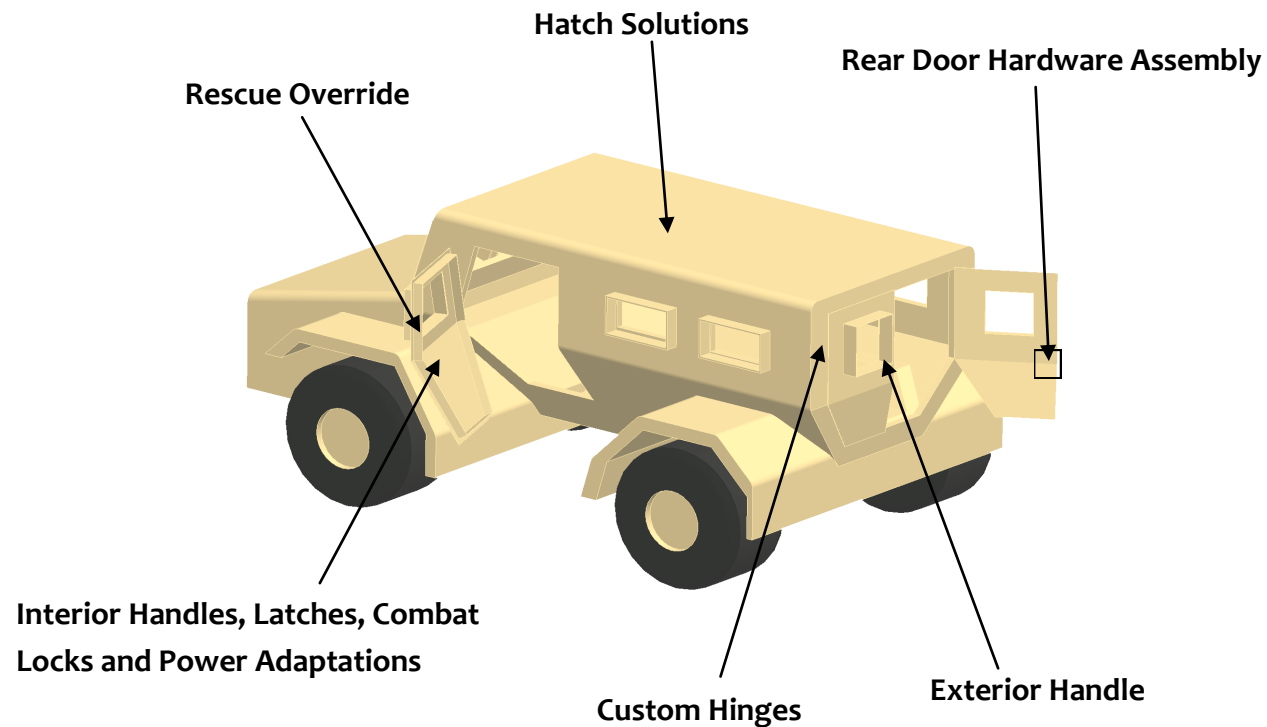

Don't Let Heavy Metals Weigh You Down



Steel is heavy - lighten up with TriMark's weight saving solutions for access hardware without sacrificing strength for the Armor Vehicle Market. All of the TriGuard line of products are purpose designed, simple to integrate, install quickly, easy to customize and feature robust construction. If there ever was a time to switch from heavy steel products, it's now.

It's just not worth the weight!

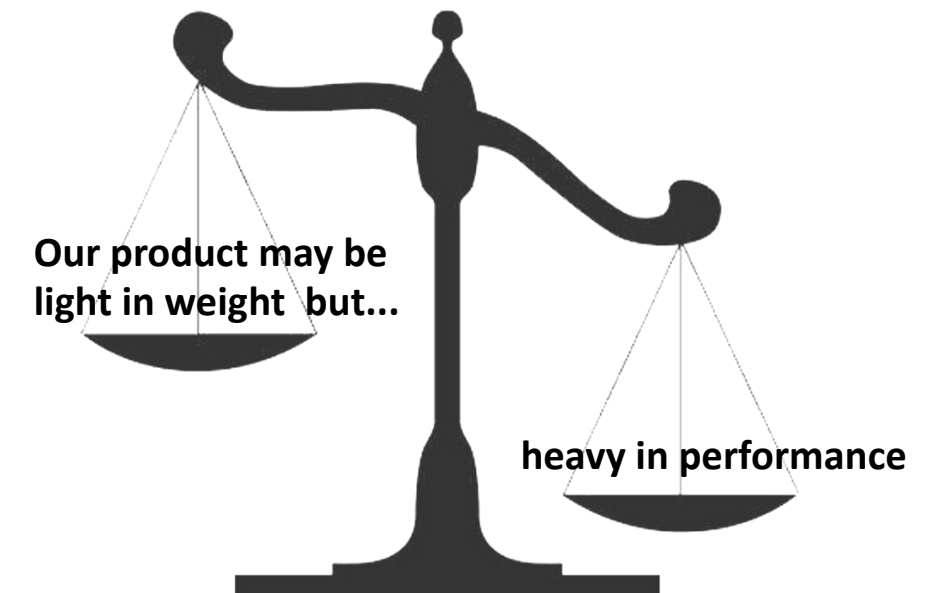

Our Capabilities are Key



Rapid production
laser and form cells

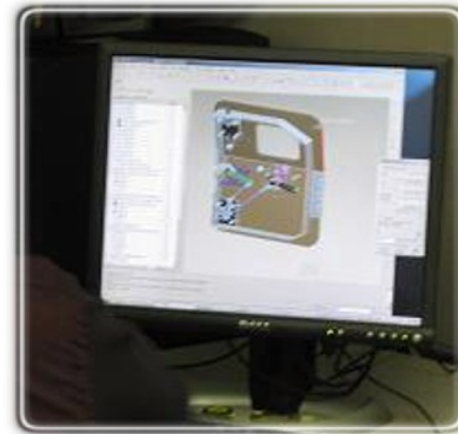

Engineering services
utilizing 3D CAD



CNC lathes/machining centers



Automated RoHS plating line



In-house quality and
inspection services

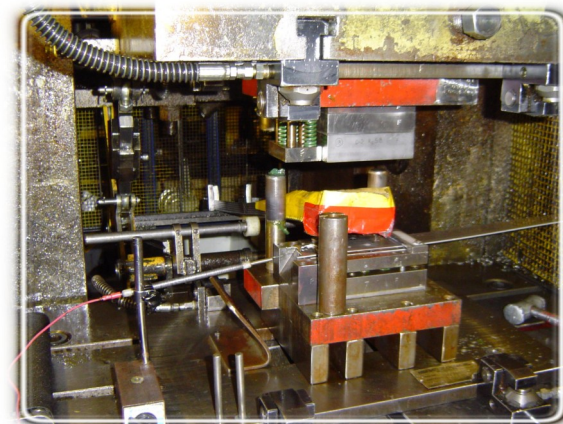

High volume stamping/
metal forming presses

Complete Door Systems

Why settle for this?

- 30+ components to source, purchase and logistically manage
- Labor intensive to assemble and adjust
- Multiple sources of supply — door components
- Complex part by part compatibility and serviceability issues

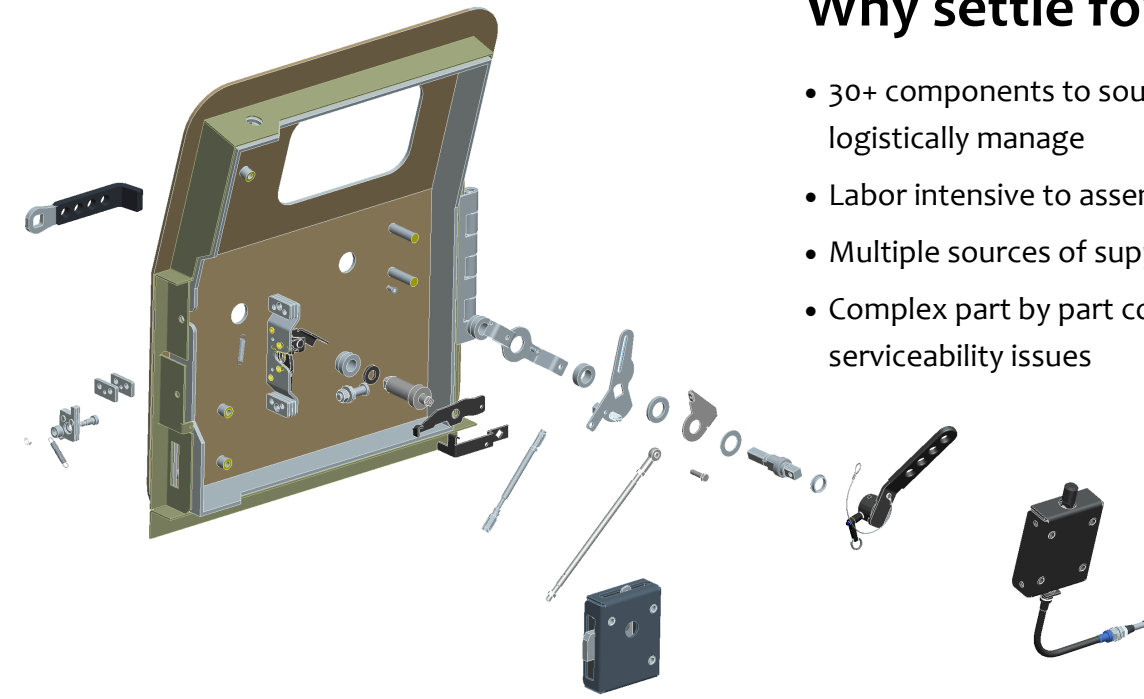

When you can have this?

- Reduces OEM Engineering time--TriMark provides expertise and complete door system design.
- Single source of supply – significantly improving supply chain logistics and cost.
- Modular one piece design is received fully assembled and pre-tested.
- Cuts door assembly time by as much as 50% to 70% -- improving vehicle cost and throughput.
- System approach reduces complexity -- fewer individual components needed
- Improved serviceability in the field and ability to retrofit into existing applications
- Improved quality, durability, reliability

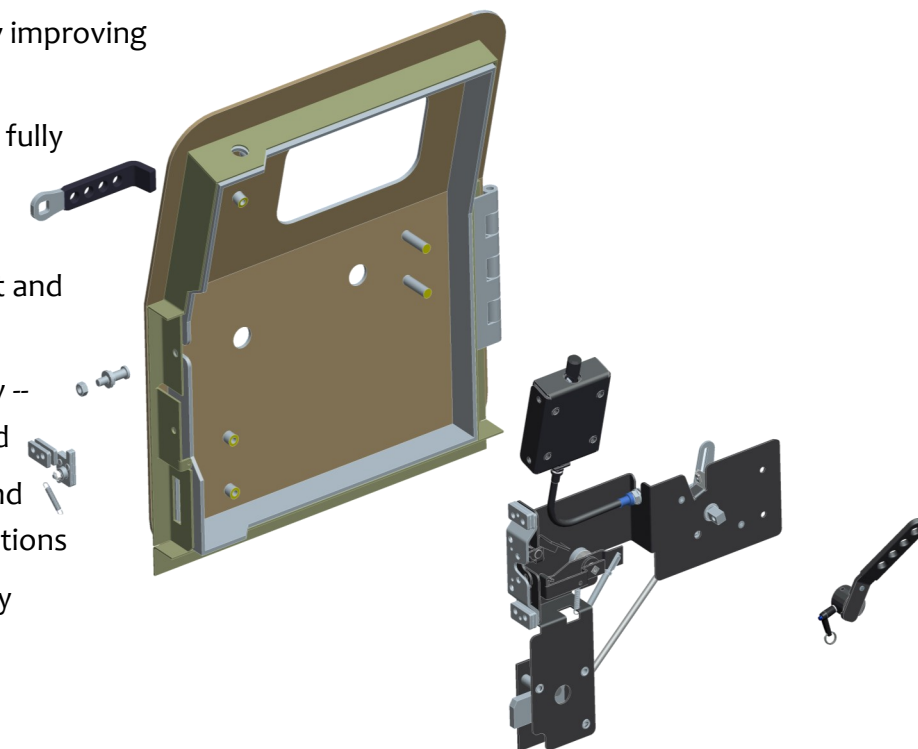

Realize the Advantages

Custom System Solution Engineered & Manufactured by TriMark

Engineering Resource Savings

TriMark's engineers can work with you to apply our door system expertise on your project to completely design and develop a robust, custom solution that meets your specifications. Additionally, **a TriMark system requires many fewer prints to be released into your system—Saving you many hours of internal design resources.**

Supply Line Savings

A TriMark door hardware system includes a fraction of the part numbers that it would take to build a door with individual components. **Fewer components mean savings in your sourcing, scheduling, ordering, logistics and inventory management.** Simplify your supply chain with TriMark!

Assembly Savings & Throughput Improvement

When it comes to installing a TriMark custom system vs. individual components, the difference is dramatic. TriMark systems are delivered to you as a single, pre-adjusted module – saving you hours on the assembly floor (**one TriMark customer saved 90 minutes per door with a TriMark custom system**)—this allows you to reduce your crew size or speed up your line to increase throughput.

Quality Improvement

When your system is designed and manufactured by TriMark, you can expect a custom engineered solution that fits your needs, but it will also be designed to maximize performance and reliability by our experienced engineers that work on door systems every day. Additionally, you won't have the quality and rework problems associated with variation of components and having to dial in multiple adjustment points. **With a TriMark system module, your process is simplified and your risk for quality problems drops.**

One Piece... One Supplier... Infinite Solutions

TriMark's Door System Example—System Savings Estimate Matrix			
Category	Conventional Door Hardware	TriMark System Module	OEM Savings
Component Count	42	5	37 per door
Fastener Count	18	12	6 per door
Engineering Hours	420	50	370 hour per vehicle
Sourcing Hours	336	40	296 hour per vehicle
Part # Cost/Year	\$420,000	\$50,000	\$370,000 per year
Door Assembly Hours	1	0.25	.75 hours per door

Complete Door Systems

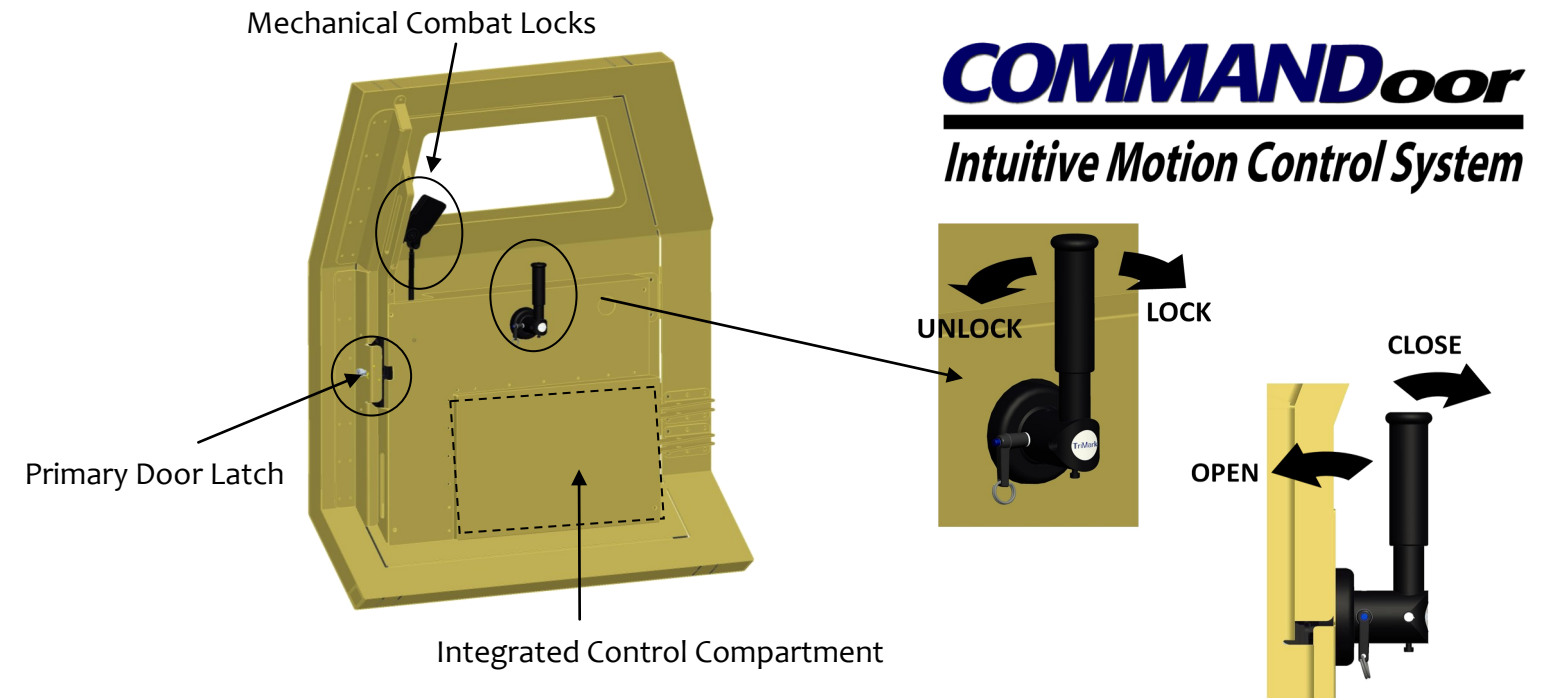

COMMANDoorPlus

COMMANDoor Plus is a complete power assist module that can simply and safely open and close the heaviest of armored vehicle doors with one intuitive motion and can be custom engineered to fit virtually any vehicle. The door fully integrates combat locks with a power-assist actuation and control system to open and close the door for those vehicles with very heavy doors. The inside control handle's unique 2-axis electromechanical design allows for simple and intuitive hand motions by the soldier to activate the open and close action of the door. Powered integration of the combat locks—automatically engaging them after door closure and automatically opening during the door opening, allows for the opening and closing of rear seat personnel doors remotely by the driver or commander from the front seat.

